

2 ΧΡΟΝΙΑ ΕΓΓΥΗΣΗ

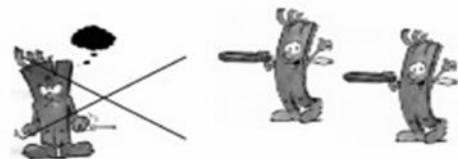

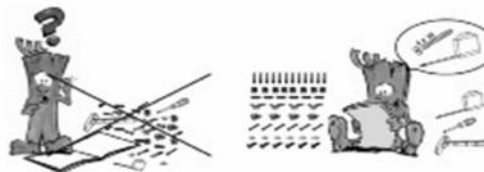



















⚠ ΑΠΑΡΑΙΤΗΤΗ Η ΣΤΗΡΙΞΗ ΣΤΟΝ ΤΟΙΧΟ



A	1434x364	2/2
B	1434x364	2/2
C	1364x361	1/2
D	650x364	2/2
E	618x361	1/2
F1	318x361	1/2
F	2x318x345	2/2
G	4x284x360	1/2
I	1310x70	1/2
H	2x650x70	1/2
J	650x345	1/2
K	650x345	1/2
L	1386x337	2/2
M	484x364	2/2
N	414x364	2/2

P	320x364	2/2
O	234x364	1/2
O1	164x364	1/2
S	1184x364	2/2
R	1350x364	2/2
T	1718x364	1/2
U	1350x70	1/2
U1	1750x70	1/2
V	360x70	1/2
W	2x245x595	2/2
Y	1100x200	1/2
Z	1100x168	1/2
Y1	1100x70	1/2
X	260x1195	2/2

52x  10174	58x  10013	56x  50317	10x  50709	24x  50332	4x  20234	70x  10033
2x  40104	46x 3.5x16  10001	4x  40102	4x  40103	2x  50000	2x 8x60  1002	1x 4x50  10009
6x 3.5x16  1006	2x  1000	4x  10174	1x 30x30  50421	4x 3x16  10004	2x 5x60  10098	1x 6x50  1001

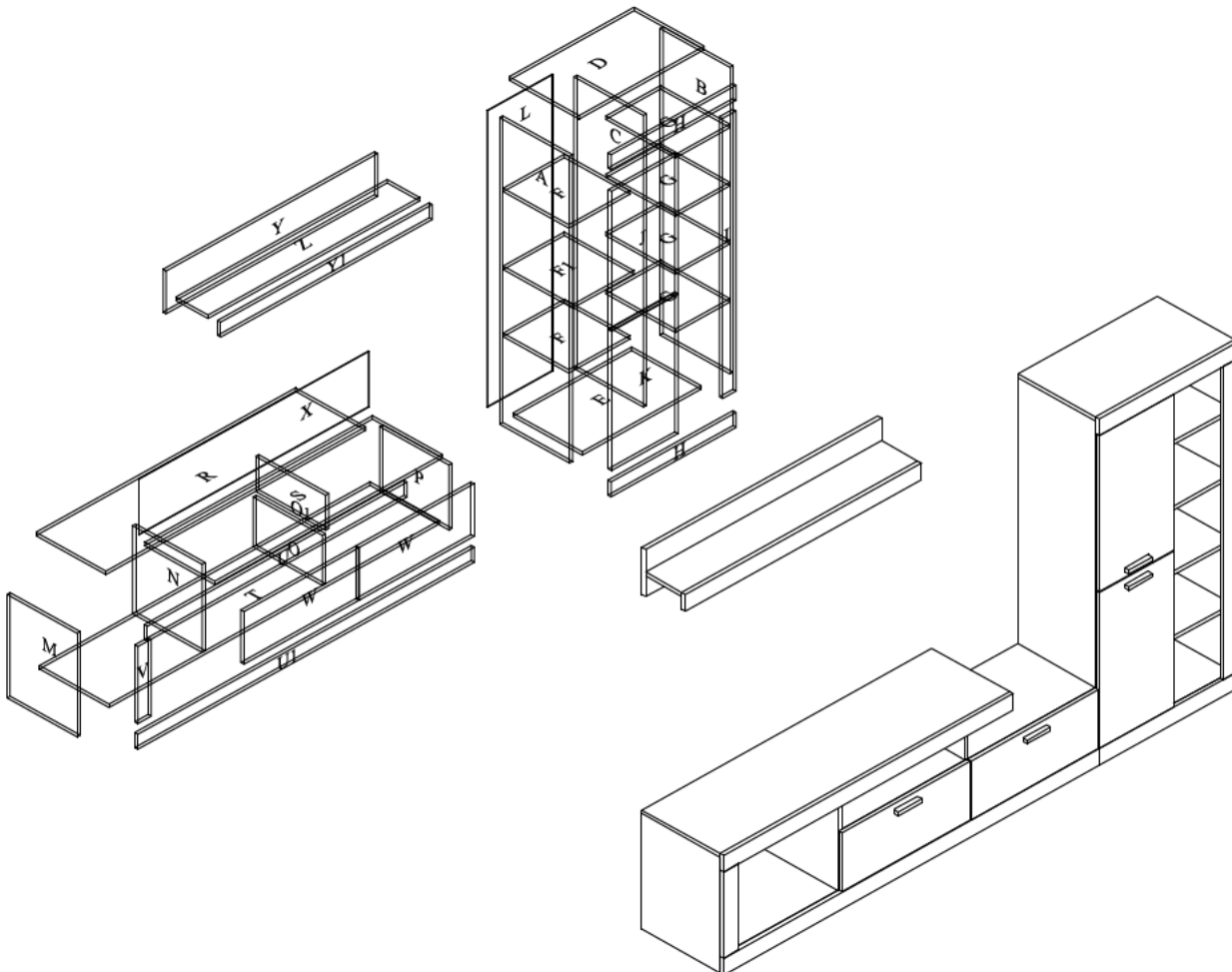

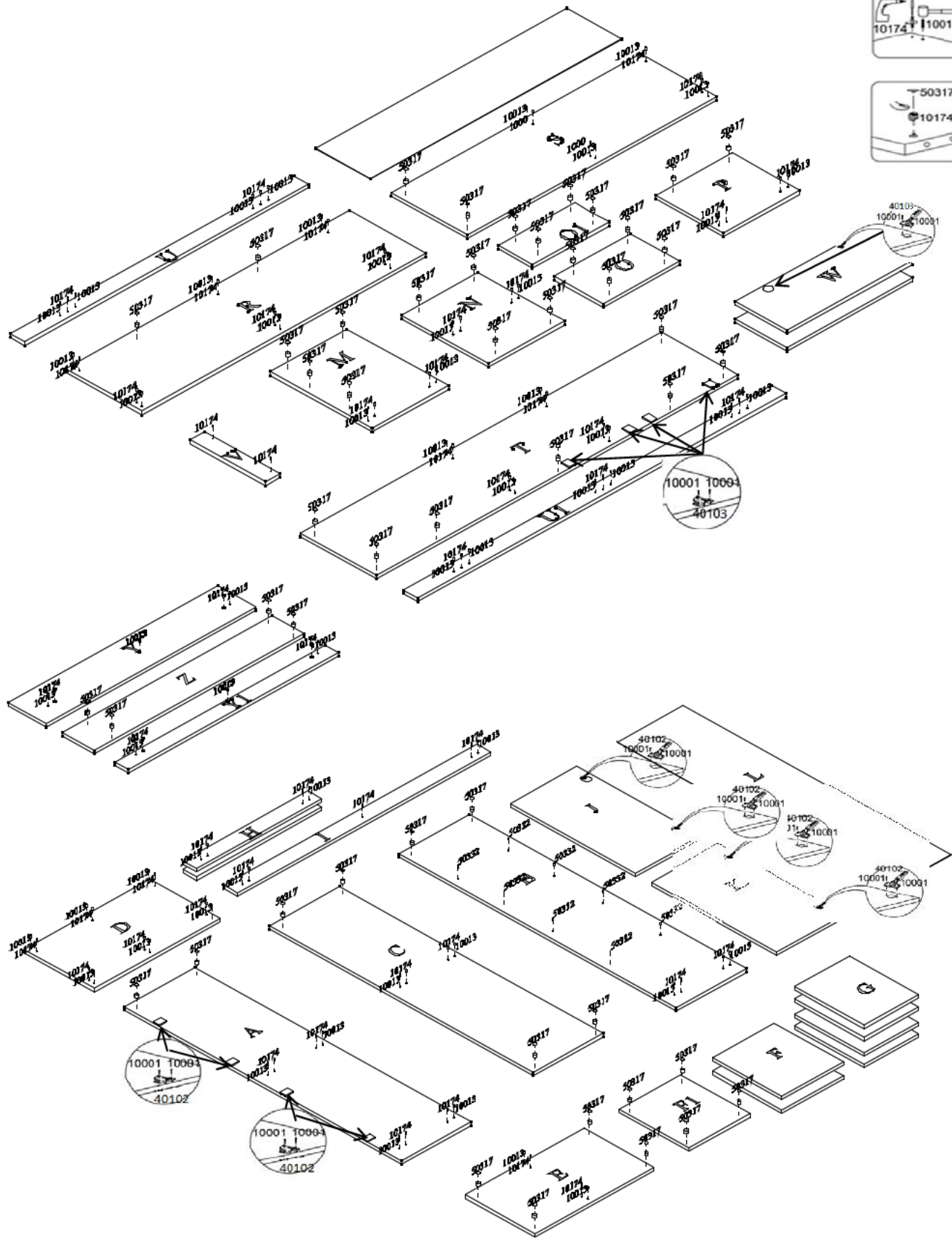
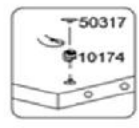
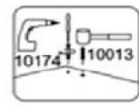

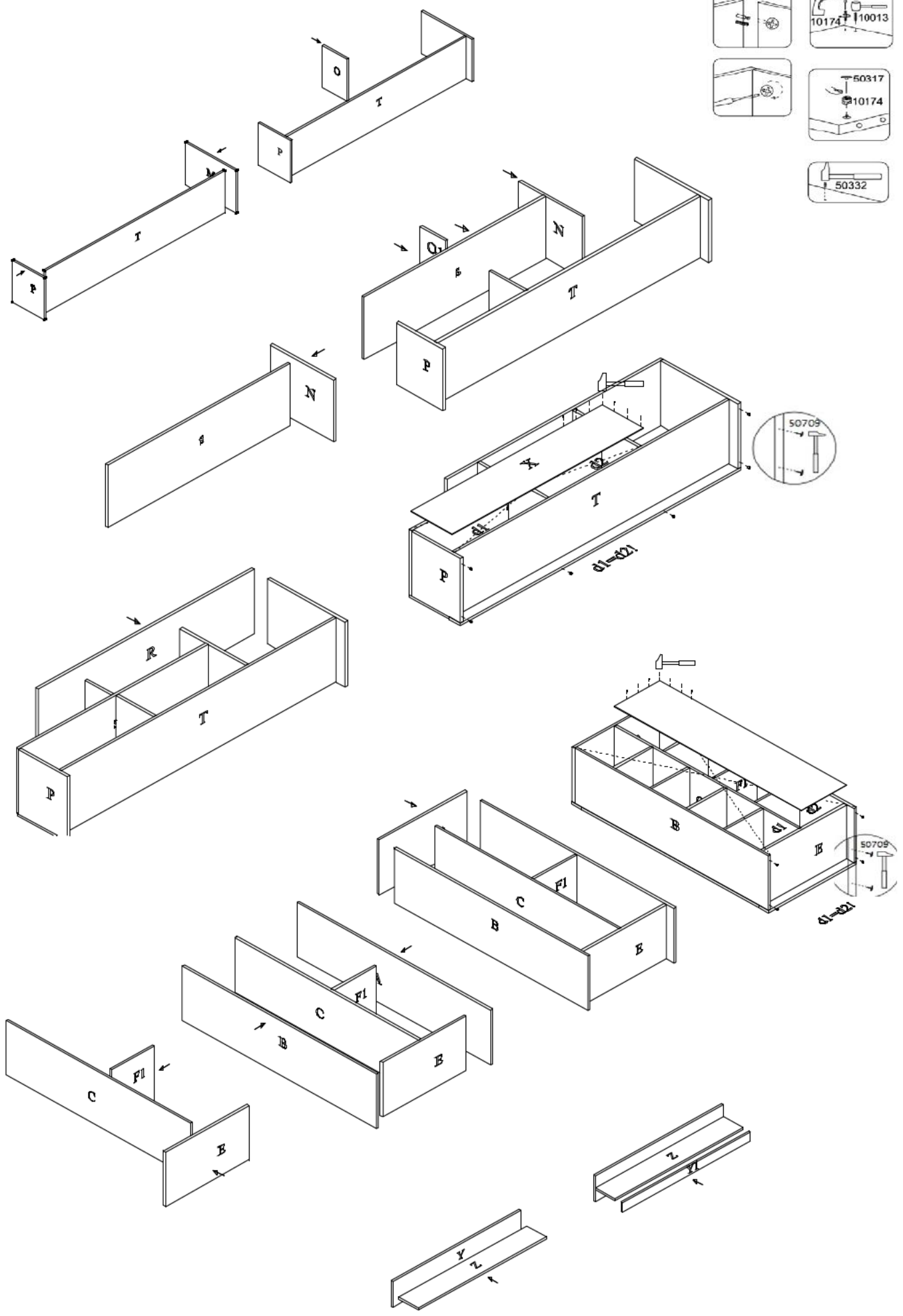

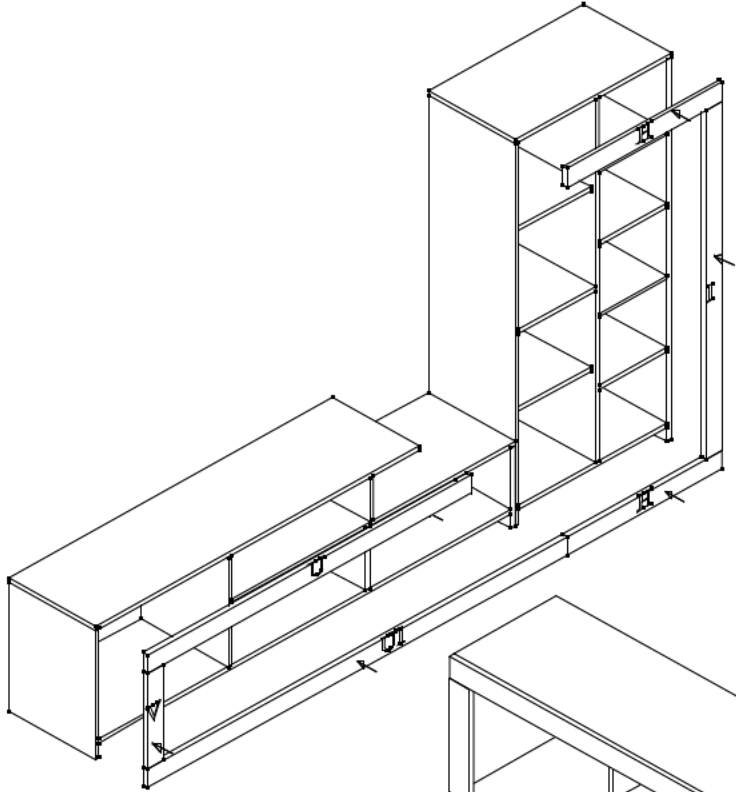

ΑΠΑΡΑΙΤΗΤΗ Η ΣΤΗΡΙΞΗ ΕΤΟΣ ΤΟΙΧΟ

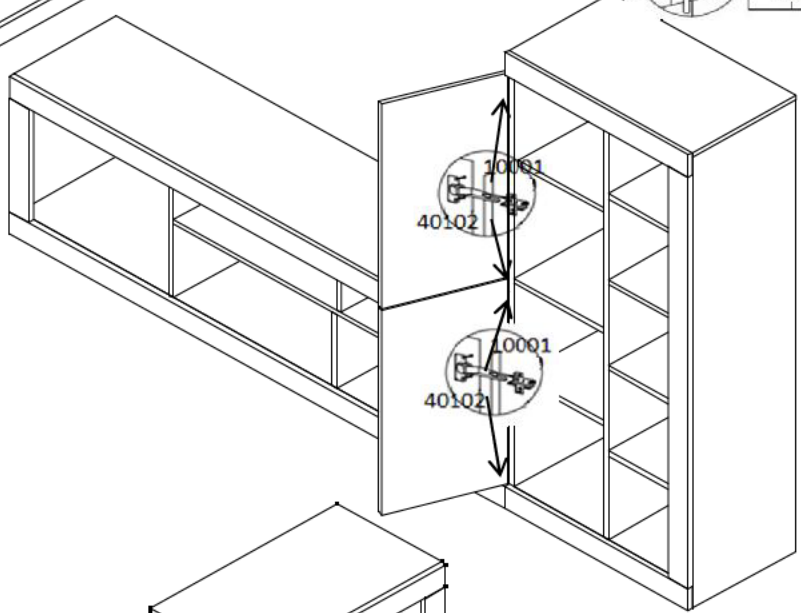
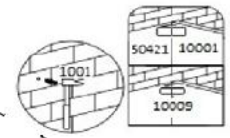

ΑΠΑΡΑΙΤΗΤΗ Η ΣΤΗΡΙΞΗ ΕΤΟΣ ΤΟΙΧΟ

