

2 ΧΡΟΝΙΑ ΕΓΓΥΗΣΗ

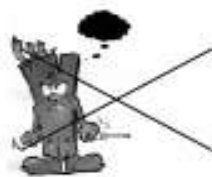

A	932x270	1/1
B	932x270	1/1
C	400x270	1/1
D	2x 368x267	1/1
E	368x267	1/1
F	368x80	1/1
G	2x 858x195	1/1

10x 	12x 	10x 	8x
10174	10013	50317	50332
4x 	26x 	1x 	1x
50709	10033	10060	10009
1x 30x30 	2x 3,5x16 		
50421	10001		

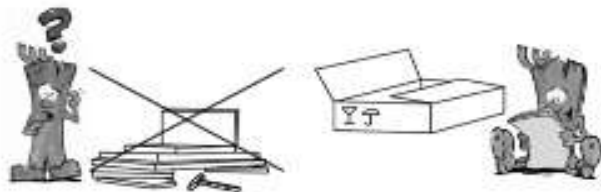
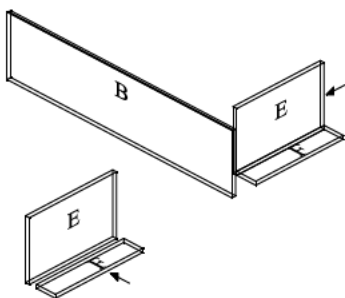
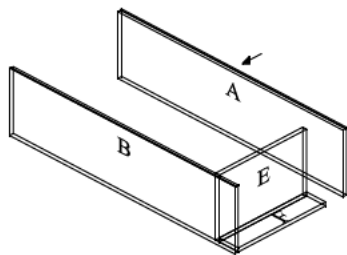
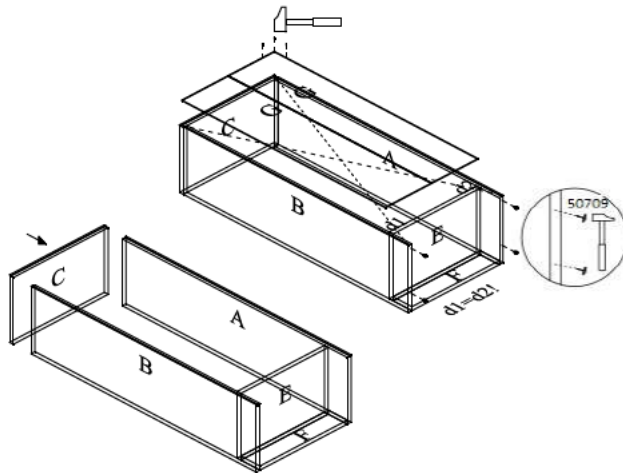
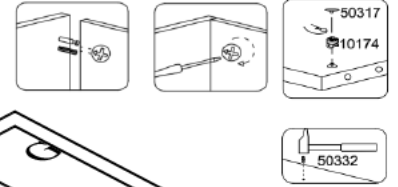
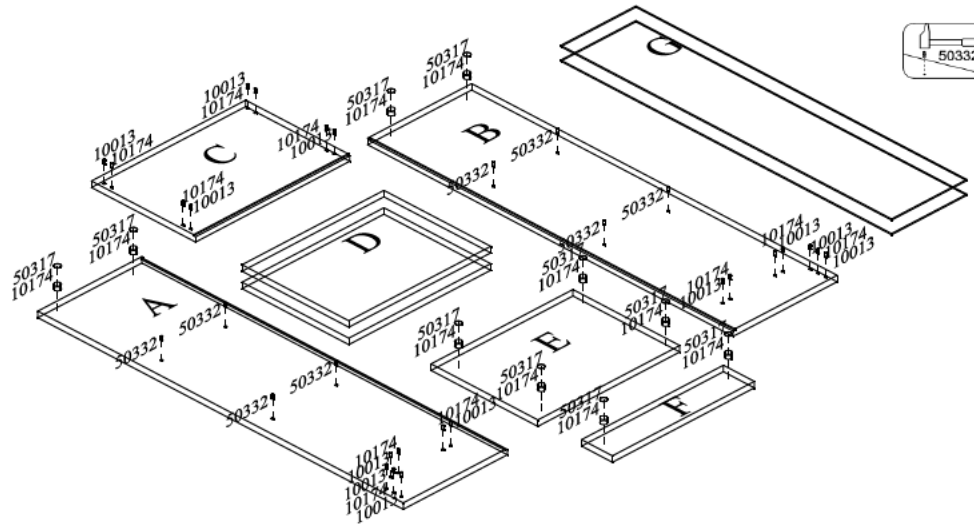
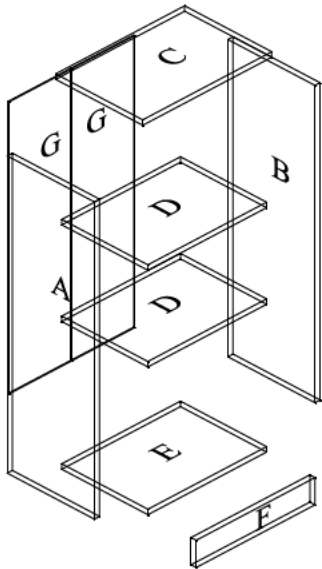

ΑΠΑΡΑΙΤΗΤΗ Η ΣΤΗΡΙΞΗ ΣΤΟΝ ΤΟΙΧΟ

