

FORCE

FLEX

INSTRUCTIONS FOR USE

FR Guide de l'utilisateur - EN User's guide - DE Bedienungsanleitung - NL Gebruiksaanwijzing - ES Guía del usuario - PT Guia de utilização - IT Manuale d'uso - TR Kullanım kılavuzu - CS Navod k použití - SK Používateľská príručka - HU Használati utmutató - PL Instrukcja obsługi - ET Kasutusjuhend - LT Naudo-totoj vadovas - LV Lietošanas pamācība - BG Ръководство на потребителя - RO Ghidul utilizatorului - SI Navodila za uporabnika - HR Upute za uporabu - BS Upute za upotrebu - SR Uputstvo za upotrebu - RU Руководство пользователя - EL Οδηγός χρήσης - UK Посібник користувача - CN 用户指南 - HK 用户指南 - KO 사용자 가이드 - AR دليل الاستعمال - FA راهنمای کاربر - FI Käyt-toopora NO Brukermanual - DA Bruger manual - MY Panduan pengguna



RH96 - TY96 - E096

PLEASE READ CAREFULLY

THE "SAFETY AND USE INSTRUCTIONS" BOOKLET BEFORE FIRST USE

FR Veuillez lire attentivement le livret "Consignes de sécurité et d'utilisation" avant la première utilisation / **DE** Lesen Sie vor dem erstmaligen Gebrauch aufmerksam die Broschüre „Sicherheits- und Bedienungsanweisungen“ durch. / **NL** Gelieve vóór het eerste gebruik aandachtig het boekje met de veiligheids- en gebruiksvorschriften door te nemen / **ES** Lea detenidamente el libro «Instrucciones de seguridad y de uso» antes de utilizar el aparato por primera vez / **PT** Leia atentamente o manual «Instruções de segurança e utilização» antes da primeira utilização / **IT** Leggere con attenzione il libretto "Norme di sicurezza e d'uso" al primo utilizzo / **EL** Διαβάστε προσεκτικά το εγχειρίδιο «Οδηγίες ασφαλείας και χρήσης» πριν από την πρώτη χρήση / **TR** İlk kullanımdan önce "Güvenlik ve kullanım talimatları" kitapçığını dikkatlice okuyun / **CS** Před prvním použitím si, prosím, pečlivě prostudujte „Bezpečnostní pokyny pro použití“ / **SK** Pred prvým použitím si pozorne prečítajte „Bezpečnostné odporúčania a použitie“. / **HU** Az első használat előtt figyelmesen olvassa el a „Biztonsági előírások és használati útmutató” című fejezetet / **PL** Przed pierwszym użyciem proszę uważnie przeczytać broszurę „Zalecenia dotyczące bezpieczeństwa i użytkowania” / **ET** Palun lugege enne esimest korda kasutamist hoolikalt ohutus- ja kasutusjuhendit / **LT** Atidžiai perskaitykite knygelę „Saugos ir naudojimo reikalavimai” prieš naudodami įrenginį pirmą kartą / **LV** Pirms izmantojat ierīci pirmoreiz, lūdzu rūpīgi izlasiet brošūru "Norādījumi par drošību un lietošanu" / **BG** Моля, прочетете внимателно книжката "Препоръки за безопасност и употреба" преди първоначална

употреба / **RO** Înainte de prima utilizare, citiți cu atenție manualul „Instrucțiuni de siguranță și de utilizare” / **SL** Pred prvo uporabo natančno preberite »Navodila za varno uporabo« / **HR** Molimo da prije prve uporabe pažljivo pročitate priručnik »Sigurnosne upute“ / **BS** Prije prve upotrebe pažljivo pročitaite knjižicu "Sigurnosne upute" / **SR** Pre prve upotrebe, pažljivo pročitaite "Bezbednosno I uputstvo za upotrebu" / **RU** Перед первым использованием внимательно прочитайте инструкцию «Меры безопасности и правила использования». / **UK** Перед першим використання уважно прочитайте посібник «Правила техніки безпеки та рекомендації щодо використання» / **CN** 请在初次使用本产品前仔细阅读「安全及使用说明」/ **HK** 第一次使用前，請仔細閱讀「安全使用說明」小冊子 / **KO** 제품을 처음 사용하기 전에 "안전 주의사항과 사용 방법"에 대한 안내 책자를 주의 깊게 읽으시기 바랍니다 / **AR** قراءه «كيب السلامة وإرشادات الاستعمال» بعناية قبل الاستعمال للمرة الأولى / **FA** لطفاً از اولین استفاده، را با دقت بخوانید / **FI** Lue huolellisesti turvallisuus- ja käyttöohjeet -esite ennen ensimmäistä käyttöä / **NO** Les nøye gjennom brosjyren «Sikkerhets- og bruksanvisning» før du bruker den / **DA** Læs omhyggeligt bogen «Sikkerheds- og brugsanvisninger» inden første brug / **SU** Läs noga igenom brosjyren «Säkerhets- och användningsinstruktioner» innan du använder den första gången / **MY** Sila baca buku arahan keselamatan tangan teliti sebelum penggunaan pertama



1 EASY WASH FILTER - **FR** Easy Wash filter / **DE** Easy Wash filter / **NL** Wasbaar filter / **ES** Filtro lavable / **PT** Filtro lavável / **IT** Filtro Easy Wash / **EL** Φίλτρο Easy Wash / **TR** Easy Wash filtre / **CS** Easy Wash filtr / **SK** Filter Easy Wash / **HU** Easy Wash szűrő / **PL** Filtr Easy Wash / **ET** Easy Wash filter / **LT** Easy Wash filtr / **LV** Easy Wash filtrs / **BG** Миещ се филтър / **RU** Фильтр Easy Wash / **UK** Фільтр Easy Wash / **CN** 易清洗过滤器 / **HK** 易清洗過濾濾 / **KO** 세척이 쉬운 필터 / **AR** فلتر سهل الغسل / **FA** Easy Wash فیلتر / **FI** Easy Wash -suodatin / **NO** Lettvasket filter / **DA** Easy Wash-filter / **SU** Enkelt tvättfilter / **MY** Penapis mudah dicuci

2 99% FILTRATION FILTER - **FR** Filtr 99% de filtration / **DE** 99% Filterung / **NL** Filter voor 99% filtratie / **ES** Filtro con 99% de filtración / **IT** 99% de filtragem / **EL** Φίλτρο που φιλτράρει το 99% / **TR** %99 filtreleme / **CS** 99% skládaný filtr / **SK** 99% skládaný filter / **HU** 99% -ig redőzőtt szűrő / **PL** Filtr z filtracją 99% / **ET** 99% filtreerimisfilter / **LT** 99% filtravimo filtr / **LV** 99% filtrācijas filtrs / **BG** 99% филтрация на праха / **RU** Nivel de filtrare 99% / **SL** 99% filtracija / **HR** Filter za 99% filtracije / **BS** Filter za 99% filtracije / **SR** 99% filtracija / **UK** Фільтр с фільтрацією 99% / **UK** Фільтр 99% фільтрації / **CN** 过滤效率高达99% / **HK** 過濾效率99% / **KO** 99% 여과 필터 / **AR** 99% فلترة وحتى / **FA** 99% تصفیه / **FI** 99% -suodatin / **NO** Filter med 99% filtrering / **DA** 99% filteringsfilter / **SU** 99% filteringsfilter / **MY** Penapis menapis 99%

3 SEPARATOR - **FR** Séparateur / **DE** Staub-Abscheider / **NL** Scheidingsteken / **ES** Separador / **PT** Separador / **IT** Separatore / **EL** Διαχωριστής / **TR** Ayırıcı / **CS** Oddělovač prachu / **SK** V závislosti od modelu / **HU** Szétválasztó / **PL** Separator / **ET** Eraldaja / **LT** Separatorius / **LV** Atdalītājs / **BG** Сепаратор / **RO** Separator / **SL** Ločevalnik / **HR** Separator / **BS** Separator / **SR** Separator / **UK** Сепаратор / **UK** Сепаратораторний фільтр / **CN** 分离器 / **HK** 分离器 / **KO** 분리기틀 / **AR** فاصل / **FA** جدا کننده / **FI** Erotin / **NO** Separator / **DA** Separator / **SU** Avskiljare / **MY** Pemisah

4 DUST CONTAINER - **FR** Bac à poussière / **DE** Staubbehälter / **NL** Stofreservoir / **ES** Depósito de suciedad / **PT** Depósito do pó / **IT** Contenitore della polvere / **EL** Δοχείο σκόνης / **TR** Toz haznesi / **CS** Nádobna na prach / **SK** Nádobna na prach / **HU** Poros tartály / **PL** Pojemnik na kurz / **ET** Tolmumahuti / **LT** Dulkių konteineris / **LV** Putekļuvertne / **BG** Контейнер за прах / **RO** Recipient de praf / **SL** Kontejner za prah / **HR** Spremnik prašine / **BS** Spremnik za prašinu / **SR** Posuda za prašinu / **RU** Контейнер для сбора пыли / **UK** Зконтейнер для пилу / **CN** 集尘箱 / **HK** 集塵箱 / **KO** 먼지통 / **AR** وعاء الغبار / **FA** وعاء غبار / **FI** Pölysäiliö / **NO** Støvbeholder / **DA** Støvbeholder / **SU** Dammbekållare / **MY** Bekas habuk

5 REMOVABLE BATTERY - **FR** Batterie amovible / **DE** Austauschbarer Akku / **NL** Verwisselbare batterij / **ES** Batería extraíble / **PT** Bateria Removível / **IT** Secondo i modelli / **EL** Αποσπώμενη μπαταρία / **TR** Çıkarılabilir batarya / **CS** Výměnitelná baterie / **SK** Vyberateľná batéria / **HU** Kivehető akkumulátor / **PL** Wymywalna bateria / **ET** Eemaldatav aku / **LT** Nuimama baterija / **LV** Nopemams akumulators / **BG** Подвижна батерия / **RO** Baterie detaşabilă / **SL** Odstranljiva baterija / **HR** Odvojiva baterija / **BS** Odvojiva baterija / **SR** Demontažna baterija /

RU В Съемная батарея / **UK** Знімний акумулятор / **CN** 可替换式电池 / **HK** 可替换式電池 / **KO** 분리형 배터리 / **AR** قارزایل قلبی قوتلوب / **FA** کرجیم ورتاب / **FI** Irrotettava akku / **NO** Avtagbart batteri / **DA** Aftageligt batteri / **SU** Löstgbart batteri / **MY** Bateri yang boleh ditanggalkan

6 CHARGING BASE - **FR** Base de charge / **DE** Ladestation / **NL** Opladstation / **ES** Base de carga / **PT** Base de carregamento / **IT** Base di ricarica / **EL** Βάση φόρτισης / **TR** Şarj istasyonu / **CS** Nabíječ základna / **SK** Nabíjačka základňa / **HU** Töltőbázis / **PL** Baza ładowcza / **ET** Laadimisalus / **LT** Įkrovimo bazė / **LV** Uzlādes bāze / **BG** Стойка за стена с възможност за зареждане / **RO** Bază de încărcare / **SL** Enota za polnjenje / **HR** Baza za punjenje / **BS** Baza za punjenje / **SR** Baza za punjenje / **RU** В зависимости от модели / **UK** док-станція / **CN** 充电底座 / **HK** 樞化吸刷 / **KO** 충전 거치대 / **AR** قاعدة الشحن / **FA** پایه شارژ / **FI** Latauslusta / **NO** Ladebase / **DA** Opladningsbase / **SU** Laddningsbas / **MY** Asas pengecasan

7 SOFA BRUSH - **FR** Brosse sofa / **DE** Polsterdüse / **NL** Meubelzuigmond / **ES** Cepillo para sofás / **PT** Escova para sofás / **IT** Spazzola divano / **EL** Βούρσα για καναπέδες / **TR** Koltuk başlığı / **CS** Kartáč na pohovku / **SK** Keňa na pohovku / **HU** Kanapé kefe / **PL** Szczotka do kanap / **ET** Diivanihari / **LT** Sofos teptukas / **LV** Divāna birste / **BG** Четка за мебели / **RO** Perie canapea / **SL** Krtača za sedežne garniture / **HR** Četka za namještaj / **BS** Četka za namještaj / **SR** Četka za namještaj / **RU** Щетка для мягкой мебели / **UK** Щітка для дивану / **CN** 樞化吸刷 / **HK** 樞化吸刷 / **KO** 소파 브러시 / **AR** فرشاة الكنب / **FA** برس مبل / **FI** Sohvaohjaaja. / **NO** Sofaborste / **DA** Sofaborste / **SU** Möbelborste / **MY** Berus sofa

8 ANIMAL TURBO BRUSH - **FR** Animal turbo brosse / **DE** Mini-Turbodüse / **NL** Turboborstel voor dierenharen / **ES** Cepillo animal turbo / **PT** Escova turbo animal / **IT** Mini turbo spazzola / **EL** Βούρσα τούριμτο για κατοικίδια / **TR** Evcil hayvan dostu turbo fırça / **CS** Turbo kartáč na zvířecí chlupy / **SK** Turbo keňa na zvieracie chlpy / **HU** Állati turbókefe / **PL** Turboszczotka Anima Turbo / **ET** Loomade turbohari / **LT** Gyvūnų turbo šepetys / **LV** Dzīvnieku turbo birste / **BG** Мини турбо четка, подходяща за косми от домашни любимци / **RO** Perie Animal Turbo / **SL** Mini turbo krtača primerna tudi za živalsko dlako / **HR** Turbo četka / **BS** Turbo četka za dlake kućnih ljubimaca / **SR** Animal turbo četka / **RU** Насадка для владельцев домашних животных / **UK** Щітка Animal Turbo / **CN** 电动涡轮吸刷 / **HK** 電動渦輪吸刷 / **KO** 반려견용 터보 브러시 / **AR** فرشاة تويو / **FA** برس حیوانات تويو / **FI** Eläintenkarvaturohajaaja / **NO** Turboborste for dyrehår / **DA** Turboborste til dyrehår / **SU** Turboborste för husdjur / **MY** Berus turbo haiwan

9 CREVICE NOZZLE - **FR** Accessoire fente / **DE** Fügendüse / **NL** Kierenzuigmond / **ES** Boquilla ranuras / **PT** Acessório para frestas e rodapés / **IT** Bocchetta lancia piatta / **EL** Πύργος / **TR** Dar uçlu başlık / **CS** Štěrbínová hubice / **SK** Štrbinová hubica / **HU** Résfűvóka / **PL** Ssawka szczelinowa / **ET** Pauguotisk / **LT** Plyšio antgališ / **LV** Plaisas sprausla / **BG** Накирник за тесни пространства / **RO** Accesoriu pentru spații înguste / **SL** Ozek nastavek / **HR** Nastavak za utore / **BS** Nastavak za uske prostore / **SR** Nastavak za uske otvore / **RU** Щелевая насадка / **UK** Насадка для щілин / **CN** 窄缝吸嘴 / **HK** 縫隙吸嘴 / **KO** 틈새 노즐 / **AR** رأس المنافخ الضيقة / **FA** هدایت مناطق باریک / **FI** Rakosuutin / **NO** Fugemunstykke / **DA** Sprækedyse / **SU** Fogmunstycke / **MY** Muncung celah



* **EN** Depending on model / **FR** Selon modèle / **DE** Je nach Modell / **NL** Afhankelijk van het model / **ES** Según modelo / **PT** Consoante o modelo / **IT** Secondo i modelli / **EL** Ανάλογα με το μοντέλο / **TR** Modele göre / **CS** Podle modelu / **SK** V závislosti od modelu / **HU** Modelltől függően / **PL** W zależności od typu / **ET** Sõltuvalt mudelist / **LT** Pagal modelį / **LV** Atbilstoši modelim / **BG** В зависимост от модела / **RO** Ovisno o modelu / **SL** Odvisno od modela / **HR** Ovisno o modelu / **BS** Ovisno o modelu / **SR** U zavisnosti od modela / **RU** В зависимости от модели / **UK** Залежно від моделі / **CN** 根据不同型号 / **HK** 根據型號 / **KO** 모델에 따라 다름 / **AR** حسب الموديل / **FA** بسته به مدل / **FI** Mallista riippuen / **NO** Avhengig av modell / **DA** Afhængig af model / **SU** Beroende på modell / **MY** Bergantung pada model

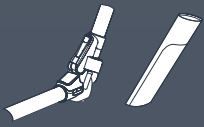

FLEX

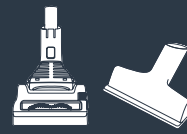

* EN Depending on model / FR Selon modèle / DE Je nach Modell / NL Afhankelijk van het model / ES Según modelo / PT Consoante o modelo / IT Secondo i modelli / EL Ανάλογα με το μοντέλο / TR Modele göre / CS Podle modelu / SK V závislosti od modelu / HU Modelltől függően / PL W zależności od typu / ET Sõltuvalt mudelist / LT Pagal modelį / LV Atbilstoši modelim / BG В зависимост от модела / RO Ovisno o modelu / SL Odvisno od modela / HR Ovisno o

modelu / BS Ovisno o modelu / SR U zavisnosti od modela / RU В зависимости от модели / UK Залежно від моделі / CN 根據不同型號 / HK 根據型號 / KO 모델에 따라 다름 / AR حسب الموديل / FA بسته به مدل / FI Mallista riippuen / NO Avhengig av modell / DA Afhengig af model / SU Beroende på modell / MY Bergantung pada model

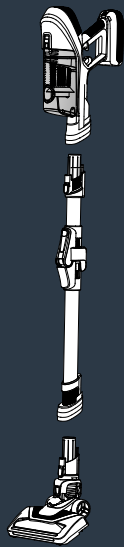

CLICK



CLICK



CLICK



ON



UP TO 45 min

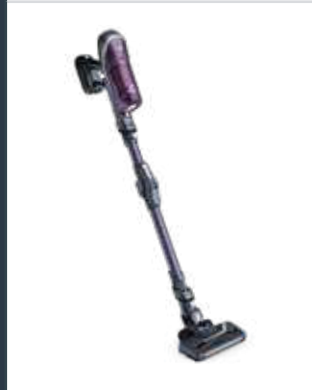

UP TO 24 min

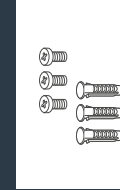
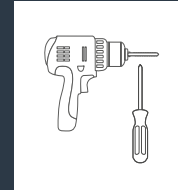

* **EN Not included** / **FR Non inclus** / **DE Nicht im Lieferumfang enthalten** / **NL Niet inbegrepen** / **ES No incluidos** / **PT Nao incluidos** / **IT Non incluso** / **TR Dahil değil** / **CS Není součástí balení** / **SK Nezahrnuté** / **HU Nem tartozék** / **PL Nie zawiera** / **ET Valja arvatud** / **LT Nėra įtraukta** / **LV Nav ietverts** / **BG Не са включени** / **RO Neinclus** / **SL Ni vključeno** / **HR Nisu uključeni** / **BS Nije uključeno** / **SR Nije uključeno** / **RU Не включено** / **EL Δεν περιλαμβάνονται** / **UK Не включено** / **CN 不包括** / **HK 不包合** / **KO 포함되지않음** / **AR غير مرفقة** / **FA شامل نمی شود** / **FI Ei sisally** / **NO ikke inkludert** / **DA ikke inkluderet** / **SU ingar ej** / **MY Tidak termasuk**

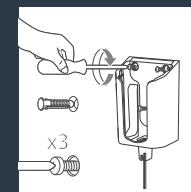
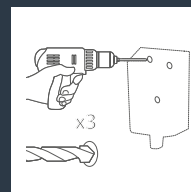
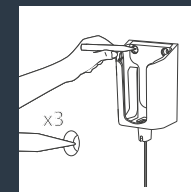
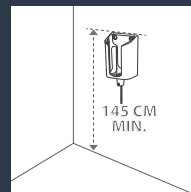
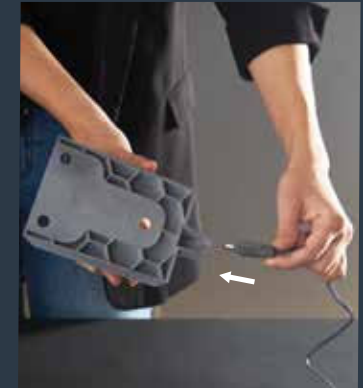
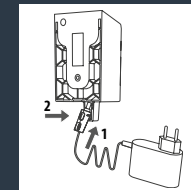
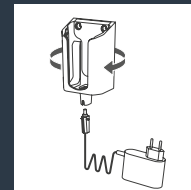



ON / OFF



BOOST

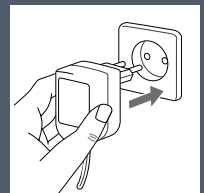
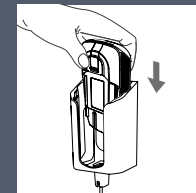
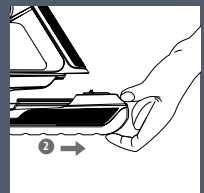
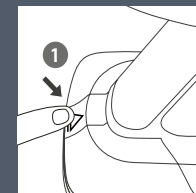
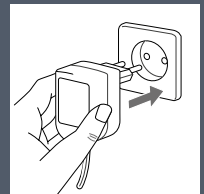
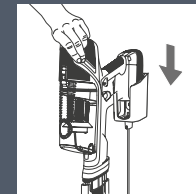
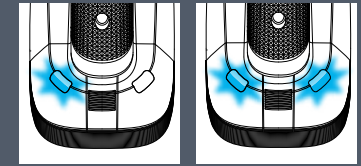
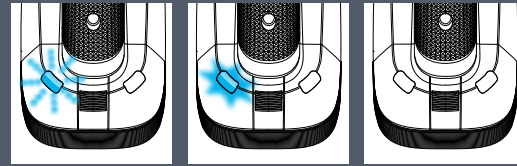



🔄 **1X / WEEK*** - * FR Semaine - DE Woche - IT Settimana - ES Semana - RU Неделя - PL Tydzień - NL Week - PT Semana - EL Εβδομάδα - TR Hafta - CS Týden - SK Týždeň - HU Hét - ET Nädal - SLV Avaité - LT Nedėļa - BG Седмица - RO Săptămână - SL Teden - HR Tjedan - BS Sedmica - SR Nedelja - UK Тиждень - CN 星期 - HK 星期 - KR 주 - AR أسبوع / FA هفته - FI Viikko - NO Uke - DA Uge - SU Vecka - MY Minggu

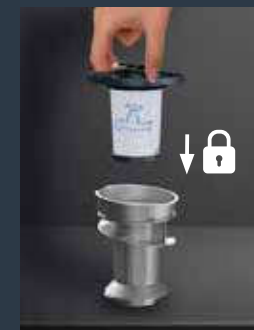
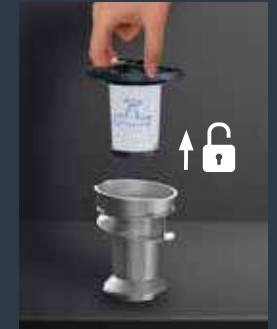
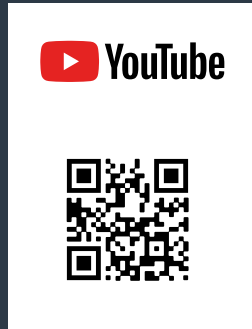



EASY WASH



99% FILTRATION

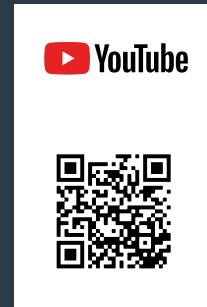
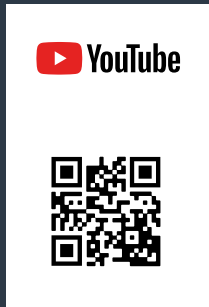

1X / WEEK* – * FR Semaine - DE Woche - IT Settimana - ES Semana - RU Неделя - PL Tydzień - NL Week - PT Semana - EL Εβδομάδα - TR Hafta - CS Týden - SK Týždeň - HU Hét - ET Nädal - SLV Avaitë - LT Nedėļa - BG Седмица - RO Săptămână - SL Teden - HR Tjedan - BS Sedmica - SR Nedelja - UK Тиждень - CN 星期 - HK 星期 - KR 주 - AR أسبوع / FA هفته - FI Viikko - NO Uke - DA Uge - SU Vecka - MY Minggu

1X / WEEK* – * FR Semaine - DE Woche - IT Settimana - ES Semana - RU Неделя - PL Tydzień - NL Week - PT Semana - EL Εβδομάδα - TR Hafta - CS Týden - SK Týždeň - HU Hét - ET Nädal - SLV Avaitë - LT Nedėļa - BG Седмица - RO Săptămână - SL Teden - HR Tjedan - BS Sedmica - SR Nedelja - UK Тиждень - CN 星期 - HK 星期 - KR 주 - AR أسبوع / FA هفته - FI Viikko - NO Uke - DA Uge - SU Vecka - MY Minggu



1X / MONTH* – * FR Mois - DE Monat - IT Mese - ES Mes - RU Месяц - PL Miesiąc - NL Maand - PT Mês - EL Μήνας - TR Ay - CS Měsíc - SK Mesiac - HU Hónap - ET Kuu - LV Mēnesis - LT Mėnuo - BG Месец - RO Lună - SL mesec - HR Mjesec - BS Mjesec - SR Mesec - UK Місяць - CN 月 - HK 月 - KR 월 - AR شهر / FA ماه - FI Kuukausi - NO Måned - DA Måned - SU Månad - MY Bulan

2X / YEAR* – * FR an - DE Jahr - IT Anni - ES Año - RU Год - PL Rok - NL Jaar - PT Ano - EL Έτος - TR Yıl - CS Rok - SK Rok - HU Év - ET Év - LT Metai - LV Gads - BG Година - RO An - SL leto - HR Godina - BS Godina - SR Godina - UK Рік - CN 年 - HK 年 - KR 년 - AR سنة / FA سال - FI Vuosi - NO År - DA År - SU År - MY Tahun



4X / YEAR – FR an - DE Jahr - IT Anni - ES Año - RU Год - PL Rok - NL Jaar - PT Ano - EL Έτος - TR Yıl - CS Rok - SK Rok - HU Év - ET Év - LT Metai - LV Gads - BG Година - RO An - SL leto - HR Godina - BS Godina - SR Godina - UK Рік - CN 年 - HK 年 - KR 년 - AR سنة / FA سال - FI Vuosi - NO År - DA År - SU År - MY Tahun





1X / WEEK* - FR Semaine - DE Woche - IT Settimana - ES Semana - RU Неделя - PL Tydzień - NL Week - PT Semana - EL Εβδομάδα - TR Hafta - CS Týden - SK Týždeň - HU Hét - ET Nädal - SLV Avaitë - LT Nedėla - BG Седмица - RO Săptămână - SL Teden - HR Tjedan - BS Sedmica - SR Nedelja - UK Тиждень - CN 星期 - HK 星期 - KR 주 - AR أسبوع / هفته - FI Viikko - NO Uke - DA Uge - SU Vecka - MY Minggu

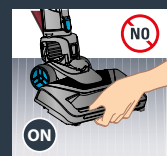
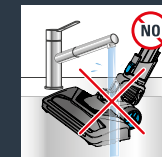
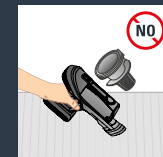
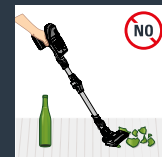
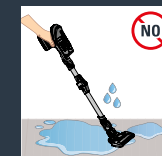
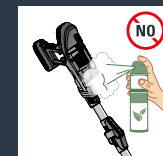
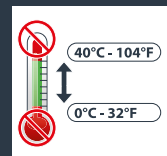
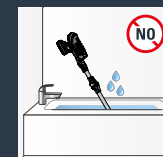
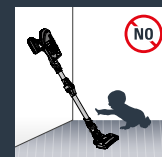
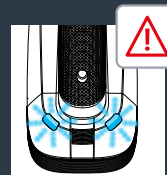
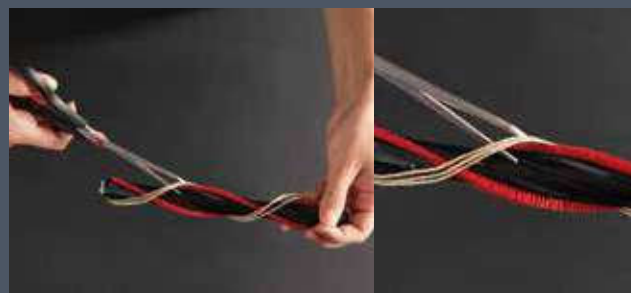
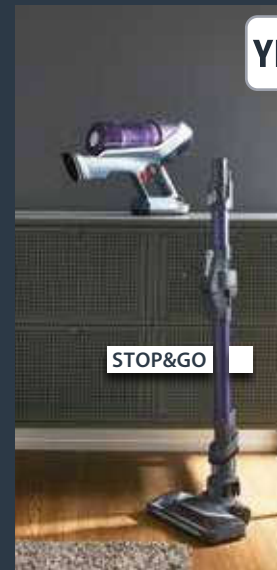
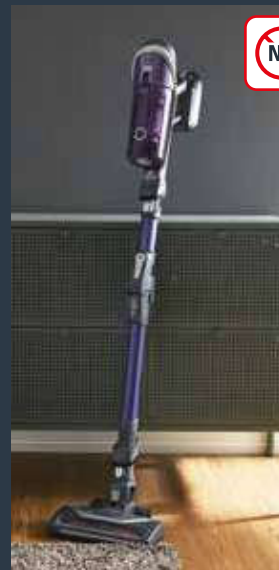
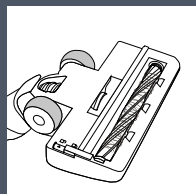
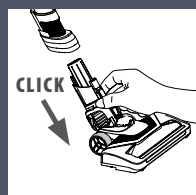
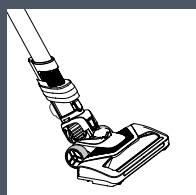
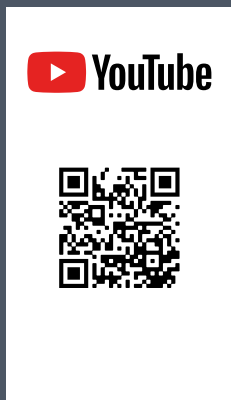

* EN Not included / FR Non inclus / DE Nicht im Lieferumfang enthalten / NL Niet inbegrepen / ES No incluidos / PT Nao incluidos / IT Non incluso / TR Dahil değil / CS Není součástí balení / SK Nezahrnuté / HU Nem tartozék / PL Nie zawiera / ET Valja arvatud / LT Nėra įtraukta / LV Nav ietverts / BG Не са включени / RO Neinclus / SL Ni vključeno / HR Nisu uključeni / BS Nije uključeno / SR Nije uključeno / RU Не включено / EL Δεν περιλαμβάνονται / UK Не включено / CN 不包括 / HK 不包括 / KO 포함되지않음 / AR غير مرفقة / FA شامل نمی شود / FI Ei sisally / NO ikke inkludert / DA ikke inkluderet / SU ingar ej - MY Tidak termasuk

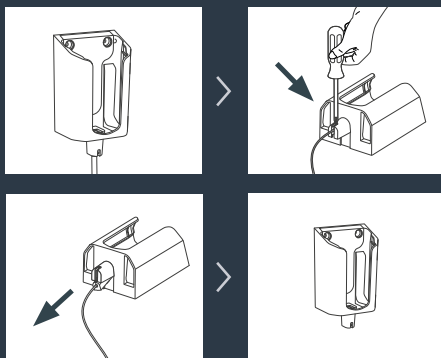

10 YEARS REPARABILITY



FR 10 ans de réparabilité
 DE 10 Jahre Reparierbarkeit
 IT Garanzia 10 anni
 ES 10 años de reparabilidad
 RU Возможность ремонта 10 лет
 PL 10 lat naprawialności
 NL 10 jaar repareerbaarheid
 PT 10 anos de reparabilidade
 EL Επισκευάσιμο για 10 χρόνια
 FI korjattavissa 10 vuotta
 NO 10 års reparerbarhet
 DA 10 år reparation

SU 10 års reparationsansvar
 MY 10 tahun boleh diperbaiki
 TR 10 yıl onarılabilirlik
 CS Opravitelnost 10 let
 SK Opravitelnost 10 rokov
 HU 10 év elkészíthetősége
 ET 10 aasta valmisõime
 LV 10 gadu sagatavošana
 LT 10 metų paruošamumas
 BG 10 години сервисна поддръжка
 RO 10 reparabilitate

SL popravljivo 10 let
 HR 10 Godina popravljivosti
 BS 10 godina popravljivosti
 SR Može se popravljati u periodu od 10 godina
 UK Придатність для ремонту 10 років
 CN 10年可維修支援
 HK 10年維修支援
 KR 10년간 수리 가
 AR قابل للإصلاح لمدة عشر سنوات
 FA قابلیت آماده سازی 10 ساله



YES



FOR MORE INFORMATION

FR Pour plus d'informations / DE Weitere Informationen / NL Voor meer informatie / ES Para más información / PT Para mais informações / IT Per ulteriori informazioni / EL Για περισσότερες πληροφορίες / TR Daha fazla bilgi için / CS Více informací naleznete zde / SK Pre viac informácií / HU További információk / PL Więcej informacji można znaleźć / ET Lisateave / LT Norėdami daugiau informacijos / LV Vairāk informācijas / BG За повече информация / RO Pentru informații suplimentare / SL Več informacij / HR Za više informacija / BS Za više informacija / SR Za više informacija / RU Для получения дополнительной информации / UK Для отримання докладніших відомостей / CN 获取更多信息 / HK 更多信息 / KO 더 자세한 정보는 아래 웹사이트에서 확인하실 수 있습니다 / AR للتزيد من المعلومات / FA كسب اطلاعات بيشتر / FI Lisätietoja / NO For mer informasjon / DA For mere information / SU För mer information / MY Untuk maklumat selanjutnya

www.rowenta.com

www.tefal.com

www.obhnordica.se

NC00165098-01 - 15/2021