

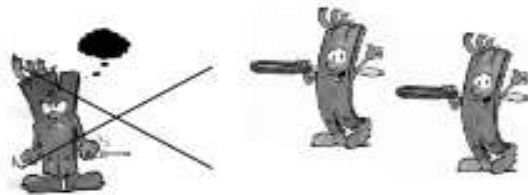

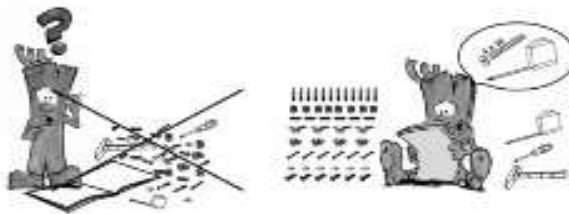

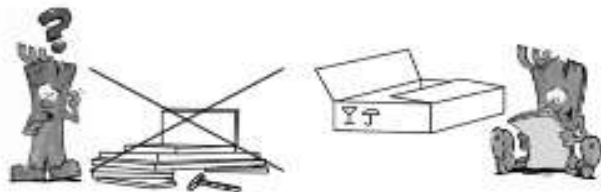



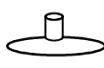

2 ΧΡΟΝΙΑ ΕΓΓΥΗΣΗ



A	1784x284	1/1
B	1784x284	1/1
C	800x284	1/1
D	4x 768x284	1/1
E	768x284	1/1
F	768x80	1/1
G	6x795x284	1/1
H	768x284	1/1

12x  10174	16x  10013	12x  50317	16x  50332
4x  50709	70x  10033	1x  6x50 10060	1x  4x50 10009
1x  30x30 50421	2x  3.5x16 10001	 10174 10013  50317  50332  50317 10174  50332	

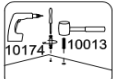
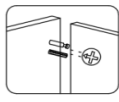
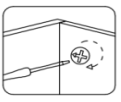
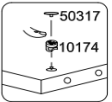
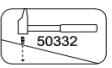
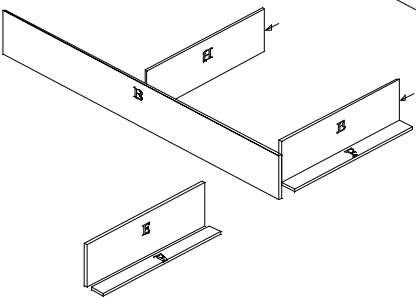
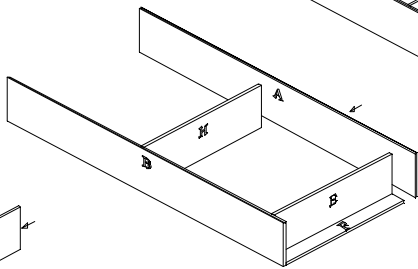
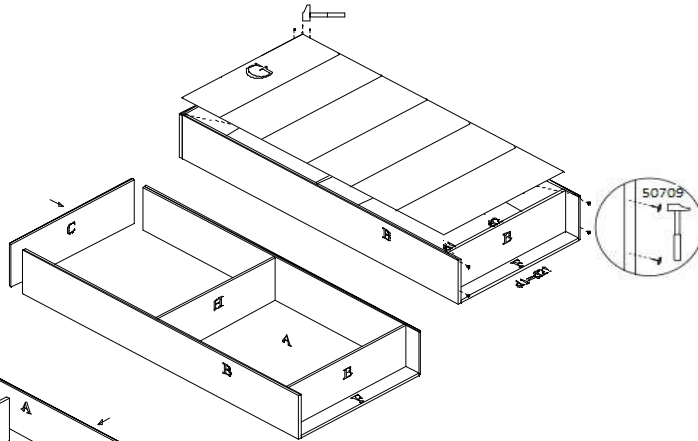
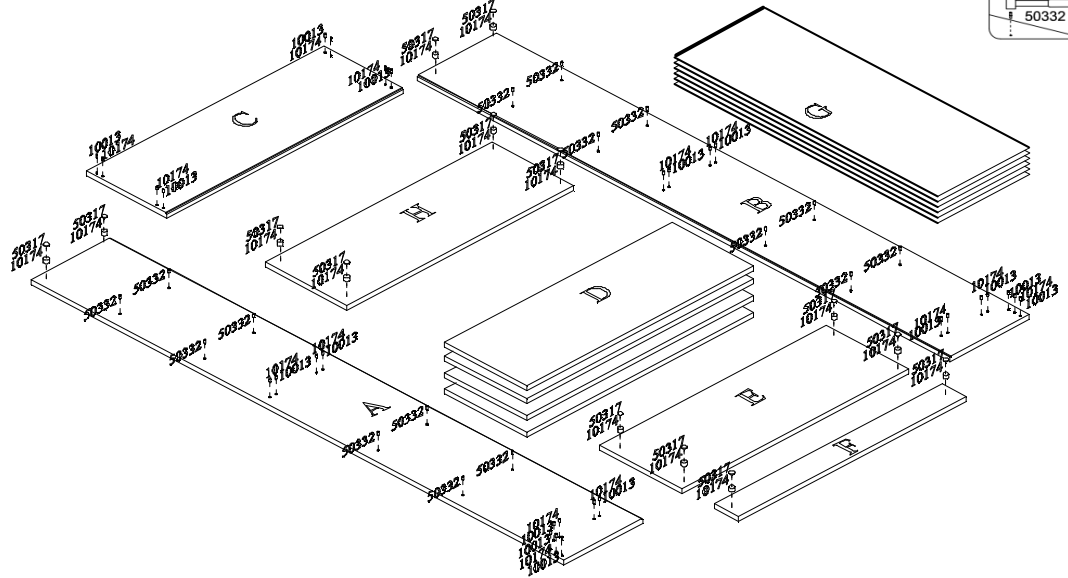
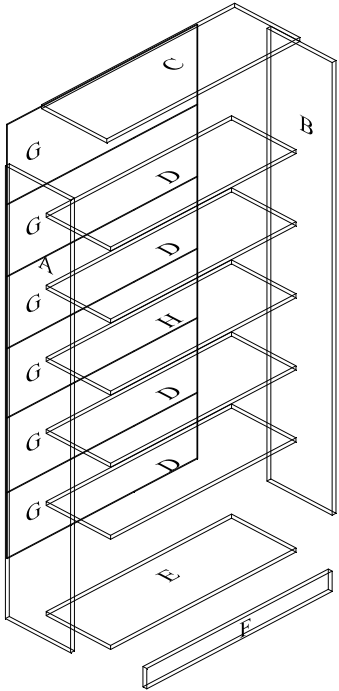

ΑΠΑΡΑΙΤΗΤΗ Η ΣΤΗΡΙΞΗ ΣΤΟΝ ΤΟΙΧΟ

