



User's Manual







Contents

Safety Warning and Notice	1
Connecting Peripheral Equipment	3
Panel Control Keys	4
Remote Control	4
Basic Operations	6
Turning on/Standby.....	6
Channel Scanning.....	6
REC (option).....	6
Instructions for Quick Start	7
Quick Start.....	7
Network Settings.....	7
Wake On Network.....	7
Pairing the Devices.....	7
Recommendations	7
Important Statement on Network Services	7
Troubleshooting	8
Technical Specifications	8

Safety Warning and Notice

The design of this product has given consideration to factors affecting personal safety, and the product has been strictly tested prior to delivery. However, improper operation may result in electric shock and fire disaster. To ensure safety, prolong the service life of this product, please read the manual and marking label carefully before using it and comply with the following safety instructions. Please keep the user manual for later use.

 Warning	May result in casualties
 Attention	May result in personal injury or property losses
	Indicate the behaviors that must be prohibited
	Indicate the operations that must be performed

- If coal gas or other flammable gases leak, do not unplug the power cord of the product or other electric appliances; instead, close the valve of the gas immediately and open the doors and windows.

- Power Under following conditions, please pull out the power plug and promptly contact the authorized professional personnel to repair.
 - Power failure or unstable voltage
 - Abnormal sound or smell from the device.
 - Power cord is damaged.
 - The product is damaged due to falling off, knock or impact.
 - Any liquid or foreign matters enter into the product.

Warning

- Only use 100-240V~, 50/60Hz power supply.
- Completely insert the power plug into power outlet, if it is loose, it may cause spark or even fire.
- Pull out the power cord plug of this product to cut off the power.
- All cables can be connected or pulled out only after power supply is turned off.
- Keep the outdoor antenna away from high voltage mains electricity wires to avoid electric shock.
- Do not fix the product in an unstable position, or else it may fall down, cause casualty or even fire. Many injuries, especially to children, can be avoided by taking simple precautions, such as:
 - Always use the furniture or brackets or installation methods recommended by the manufacturer of the product.
 - Only use the furniture that can safely support the television set.
 - Ensuring the product is not overhanging the edge of the supporting furniture.
 - Do not place the product on tall furniture (for example, cupboards or bookcases) without anchoring both the furniture and the product to a suitable support.
 - Do not place the product on cloth or other materials that may be located between the product and supporting furniture.
 - Educating children about the dangers of climbing on furniture to reach the product or its controls.
 - Do not place objects which may tempt children into climbing, such as toys and remote control, on top of the product or on top of the furniture where the product is placed.
 - If the existing product needs to be relocated, the same factors as above should be considered.
- Do not place the product at any place susceptible to mechanical vibration.

Warning

- Do not put the product in the environment:
 - With direct sunshine, moisture, overheating, undercooling or heavy dust;
 - With flammable or explosive substance;
 - With flammable or corrosive gas;
 - In bathroom, kitchen, etc.
- Do not use damaged or improper power socket, and ensure that the plug and socket are connected properly.
- Keep the power plug and socket free of dust and metal pieces.
- Do not damage the power cord:
 - It is prohibited to refit the power cord;
 - Do not put heavy object on the power cord;
 - Keep the power cord away from heat source;
 - Do not drag the power cord when unplugging.
- Do not connect too many appliances to one power strip, or else it may cause fire due to high power consumption.
- Do not let open flame (e.g. lit candle) approach the product, or else it may cause electric shock or fire.
- Do not put the container filled with water on the product, to avoid electric shock or fire caused by water drop of splashing.
- Do not penetrate any sharp object, metal or liquid into the signal connector or air vents, to avoid short circuit and product damage as well as electric shock.
- The slots on the case is designed to release heat so as to assure that all inside components will not reach an extra high temperature and can work normally for a long time. Please do not cover the holes while place the product.
- For adequate ventilation, there should be at least a 30cm gap or distance between the product and other objects. Insufficient ventilation space can cause overheating and may result in damage or even a fire.
- Do not put the product in limited space, e.g. bookcase or embedded closet, unless the product is properly ventilated.



Do not touch the plug with wet hands, or else it may cause electric shock.



Do not turn on the product in thunderstorm weather; instead, unplug the power plug and antenna connector to avoid lightning strike.



Do not disassemble the product privately, or else it may cause electric shock or fire. Contact qualified personnel for maintenance.

Attention

- Keep the small accessories away from children's reach to avoid swallowing.
- Do not mount the product against air conditioner, or else the internal panel of the display may condense moisture and cause failure.
- Do not place the product at any place with strong magnetic field, or else it may be interfered with and damaged by electromagnetic wave.
- If the product won't be used for a long time, please turn off it and unplug the power cord.
- Before cleaning the product, unplug the power cord and wipe with soft cloth; do not use chemical reagents and avoid foreign substances entering into the product. The incorrect cleaning (such as cleaning fluid, water, etc) may lead to damage of product's appearance, erasing products printing information, even flow into the machine and damage components, cause no display of machine.
- To adjust the position or angle of the product, please disconnect all wires and move slowly to avoid falling down.
- Do not rub with hard object, knock at, bend or squeeze the LCD screen.
- Do not use the product immediately after transferring it to the places with high temperature from the place with low temperature, which will cause fogging inside and failures.
- If the LCD screen is broken and the liquid splashes on skin, please wash with clean water immediately for 15 minutes, and go to see your doctor.
- Do not put stress on the panel when carrying the product with hands.
- Displaying the same image for a long time or the active image with fixed words, icons will leave "image sticking" on screen which will not disappear after powering off for a long time. This defect is not covered by warranty.
- Watch in appropriate light; poor light or long time watching may hurt your eyes.
- Adjust the volume appropriately to avoid hurting your hearing.
- If a power plug or appliance coupler is used as disconnecting device, it should ensure easy operation.
- All the technical specifications in the user manual and on the package are subject to changes without prior notice. If there is slight deviation between the user manual and actual operation, the latter shall prevail.

Google TV is the name of this device's software experience and a trademark of Google LLC. YouTube, Google Cast and YouTube Music are trademarks of Google LLC.



The terms HDMI, HDMI High-Definition Multimedia Interface, HDMI Trade dress and the HDMI Logos are trademarks or registered trademarks of HDMI Licensing Administrator, Inc.

Connecting Peripheral Equipment

Remark:

1. The type, location, arrangement and number of interfaces for different models vary. The interface of the specific model depends on the actual situation.
2. HDMI connector can realize DVI connector function with external HDMI/DVI commutator.
3. The peripheral equipment and cables described in this manual should be purchased separately.

Warning

When connecting outdoor antenna to signal port of the TV set, please turn off the main power switch of the TV set first. Do not approach the outdoor antenna to high voltage mains power line to avoid electric shock. The wired network antenna connected to this TV set must be isolated from the protective grounding, or else it will cause fire or other hazards.

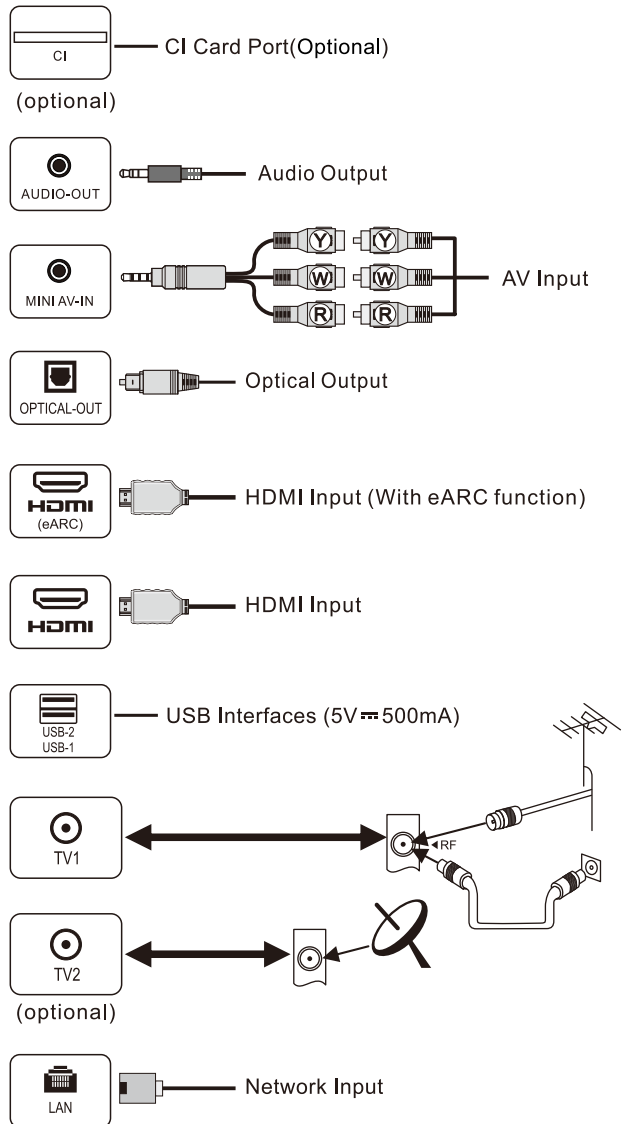
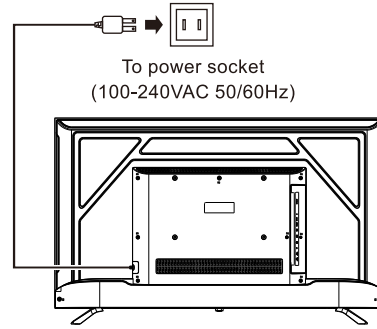

- Yellow (VIDEO signal cable)
- White (AUDIO-L signal cable)
- Red (AUDIO-R signal cable)

Panel Control Keys

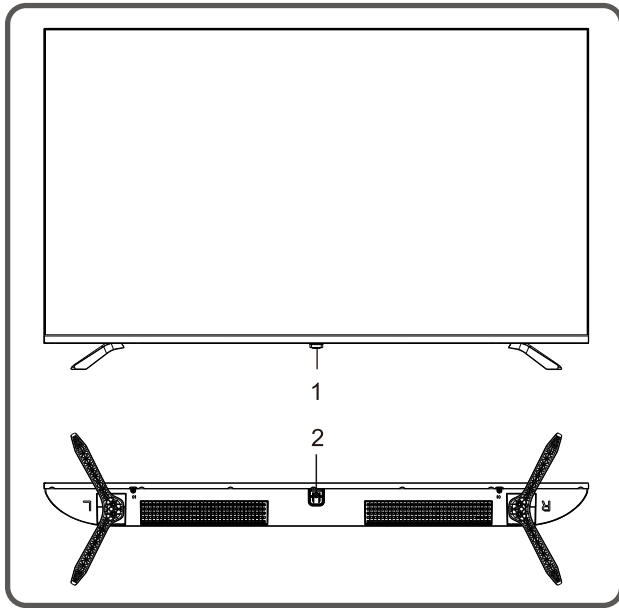

1. Power LED indicator and remote receiving window.
2. ⏻ Standby: To switch the TV on or back to standby.

Remark:

- ①. The appearance varies depending on the model, and the actual product shall prevail.
- ②. Please use the remote control for more operation.

Remote Control

Method for Installation of Remote Control Battery

Remove the battery compartment cover and insert two AAA (No. 7, 1.5V) batteries; make sure the polarity of the batteries is in compliance with the polarity mark "+" and "-" in the battery compartment of the remote control.

Precautions for Using Remote Control:

- Do not place objects between the remote control and the remote control sensor window.
- Strong lighting affects the remote control sensor window, please adjust the angle of lighting or the product, or operate the remote control near the remote control sensor window.
- Do not expose the battery to overheating environments such as sunlight or fire, or charge, heat or incinerate, mechanically crush or cut the battery, as this may cause an explosion.
- Do not place the battery in an environment with extremely high temperature or extremely low air pressure that may cause the battery to explode or leak flammable liquids or gases.
- If the remote control is not in use for a long time or the batteries are dead, please remove the batteries.
- Please do not use batteries of different types. It is not allowed to use old and new batteries together; the batteries should be replaced in pair.
- The waste batteries contaminate the environment, please dispose the waste batteries pursuant to relevant regulations on environmental protection.

Voice Remote Control Operation Manual

Pairing the voice remote control

If the remote control is not paired, press the Google Assistant key, then long press [←] + [🏠] keys to pair. When the TV show the device, select it and press [OK] key to finish.

Note:

1. Some models may not be supported.
2. Your Location must correspond to the language for exact search results. Some functions may not be available if your location settings and language settings are different.
3. You can change the language according to language input settings. The languages available for Google Assistant may be changed in accordance with service operation policy.

- 4. Details of service may vary by model.
- 5. Before you use Google Assistant, you should make sure remote control paired.

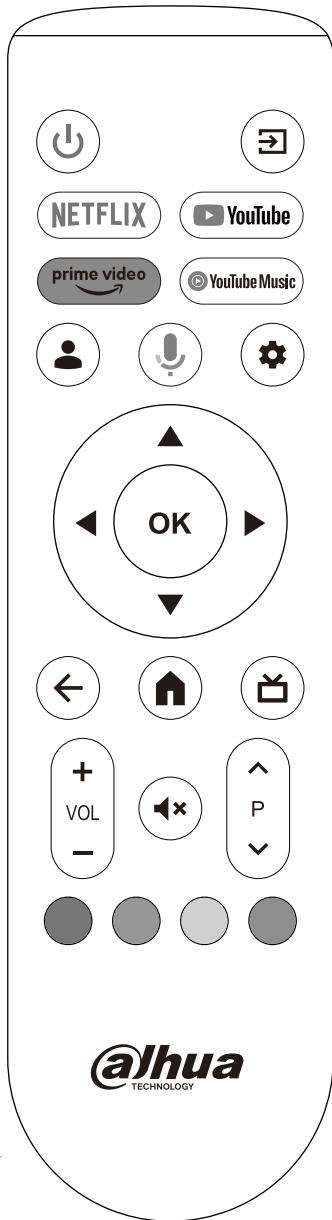

Keys of the Remote Control

Note: The appearance of the remote control may be different from this diagram; please refer to the real object as standard.

Keys	Function
	Switch between working and standby status.
	Show signal source menu.
NETFLIX	Open application.
	Open application.
prime video	Open application.
	Open application.
	Manage Google Account. (It is valid after login)
	Microphone / Google Assistant Ask Google Assistant to find movies, stream apps, play music, control the TV and more - all with your voice.
	1. Display the Dashboard interface. 2. Show the main menu. (In TV mode)
	1. Select items or adjust values. 2. In TV mode, press [▲]/[▼] key to change channel.
OK	1. Open channel list. (In TV mode) 2. Confirm the operation.
	Return to previous menu or exit the menu.
	Show home page.
	Electronic program guide.
P ▲ / ▼	Change channel.
	Turn on/off the sound.
VOL +/-	Turn up/down the volume.
Red key	Special function keys.
Green key	
Yellow key	
Blue key	

Note: During menu operation, the icons of invalid options are gray.

Basic Operations

Remark:

1. The keys operation here refers to remote control operation, as for panel control keys operation, please refer to "**Panel Control Keys**".
2. Menu Operation Instruction in this manual explains the operation under TV mode, which could also be the reference to other modes.
3. Before powering on platform, please make sure that the power supply is stable.
4. The software of different countries is different. The specific software operation should be subject to the actual situation.
5. Because the product is constantly updated, the software is upgraded at any time, if the software operation is different from the actual operation, please refer to the actual product.

Turning on/Standby

Plug power cord into the electrical socket, then press [**⏻**] key to turn on the TV. When it is the first time to turn on the TV, the initialization settings interface appears, please set it as needed.

Note: *If it is the first time to start up, the software of corresponding standard is displayed after the country is selected.*

In power on state, press [**⏻**] key to switch to standby mode.

Channel Scanning

Before scanning, please make sure that the antenna has been connected properly.

Select the TV signal source. Press [**⚙**] key, select **⚙ > Channels & Inputs > Channels**, and press [**OK**] key to enter, then operate as needed.

REC (option)

Note: *REC function is not available in certain countries.*

Before recording, insert the USB mass storage device into the USB interface.

In DTV mode, press [**⚙**] key, and select **Record > Device info > USB drive > Set PVR**. Press [**⚙**] key, and select **Record > Start Recording**, then press [**OK**] key to start recording. In the process of recording, press [**⚙**] key, and select **Record > Stop Recording**, then press [**OK**] to save and exit recording.

Press [**⚙**] key, then select **Record > Record List**. Select the file that you want to play, then press [**OK**] key to play it.

While playing, press [**OK**] key to stop playing. You can press [**←**] key to exit playing.





Note: *Only the memorizer with FAT32 file system supports the recording function.*

Instructions for Quick Start

Note: Please log in to your Google Account to get access to more features.

Quick Start



Language input setting

In the smart mode, select the system language. Press [] key, and select  > **System > Language**, and press [OK] key. Press []/[] key to select the desired language, and then press [OK] key.

Selecting Input Method

In the smart mode, press [] key, and select  > **System > Keyboard > Current keyboard**, and press []/[] key to choose input method.

Setting System Time

In the smart mode, press [] key, and select  > **System > Date & Time > Automatic date & time**, then select **Use network-provided time**. You can also set the system time manually.

Network Settings

In smart mode, press [] key, select  > **Network & Internet > Wi-Fi/ETHERNET**, and press [OK] key to enter, then set as needed.

Note: Before using a wired network, connect one end of the network cable to the local network interface and the other end to the router.



Wake On Network

It allows remote systems to wake up the sleeping TV by sending a frame of a specific format which the client anticipates. (It is available when network is connected.)

Note: *The network wake up operation varies according to the software version.*

Press [] key, and select  > **System > Power & Energy > Energy Modes > Optimized**, and press [OK] key to turn on **Networked Standby**.

Pairing the Devices

In smart mode, press [] key, and select  > **Remotes & Accessories**, then press [OK] key to enter. Select **Pair accessory**, and press [OK] key, then follow the prompt to connect.

Note: Select  > **System > About > Device name**, and you can check the TV name.

Recommendations

Google Assistant

Use your voice to search for shows, control devices, and more - just ask Google Assistant.

Google Cast™

Easily cast movies, shows, photos, and more from your phone or tablet, right to your TV.

Important Statement on Network Services

All contents and services obtained from this TV set belong to the third party and are protected by laws on copyright, patent right, trademark right and/or other intellectual property right. The said contents and services are only for your non-commercial purposes. It is not allowed to use any content or service without the authorization of the content owner or the service provider.

Our company will undertake no liability for any direct, indirect and accidental losses or damages caused by your or a third party's access to any content or service or any information or any third party software through this set under any circumstances.

Third party service may be changed, deleted or stopped without prior notice. Our company neither implies nor guarantees the continuous availability of some service or content within any period of time.

Our company is not held responsible for services related to the said service and content. Besides, we will not bear any liability for client service. Please directly contact relevant content and service providers if you have any problem and service request concerning relevant service or content.

Troubleshooting

- **Snowflake spots occur in the TV images and there is noise in accompanying sound.**
 1. Check if the antenna plug is loose or the cable is in good condition.
 2. Check the antenna type (VHF/UHF).
 3. Adjust the direction and position of the antenna.
 4. Try to use signal enhancer.
- **There is neither display nor sound on the screen. The indication light is not on.**

Check if the power line is connected.
- **Dotted line or strip disturbance occurs in TV images.**

Do not use electric hair dryer aside the TV set and adjust the antenna direction to reduce disturbance.
- **Double images occur on the TV screen.**
 1. Use high oriented antenna.
 2. Adjust the direction of the antenna.
- **The TV has no accompanying sound.**
 1. Adjust the volume to a proper degree.
 2. Press [MUTE] key on the remote control to cancel mute mode.
- **No signal input images show on the machine screen. The indicator light is blinking.**
 1. Check if the signal connecting cable is loose or falls off. Reconnect it.
 2. The machine may be in standby mode, please reboot.
- **The remote control distance is short or out of control.**
 1. Remove the object to avoid blocking the remote control receiving window.
 2. Replace the battery.
- **The browser cannot access any link.**
 1. Ask the network administrator to obtain available IP address and other parameters.
 2. Check if the network connecting cable is normally connected.
 3. Consult the network service provider.
- **Online video play is very slow.**
 1. Please upgrade your network bandwidth to a higher one.
 2. Please try to replace with other addresses to obtain better resources.
- **Machine is slow, system crash, can't operate the machine.**

Disconnect the power supply first, and connect the power supply after about 1-2 minutes, then turn on the TV again.

Technical Specifications

Technical specifications for TV

1. Supported standard:
 - Different countries have different standards. The actual situation prevails
 - ATV:** PAL+SECAM;
 - DTV:** DVB-T/C(DVB-T2/S/S2 option).
2. Antenna input: 75Ω coax, unbalanced.
3. Specific internal memory capacity in accordance with actual configuration.
4. Specific cache capacity in accordance with actual configuration.
5. Wireless connection: Wi-Fi (IEEE 802.11 a/b/g/n/ac).

HDMI display mode

Video mode			
NO.	Mode	Resolution	Refresh rate
1	SD	720×480i/p	60Hz
2		720×576i/p	50Hz
3	HD	1280×720p	50Hz
4			60Hz
5	FHD	1920×1080i/p	50Hz
6			60Hz
7	UHD	3840×2160p	24Hz
8			25Hz
9			30Hz
10			50Hz
11			60Hz

Remark: Under UHD mode, 50Hz and 60Hz refresh rate is effective only under HDMI version 2.0/2.1.

VESA mode			
NO.	Mode	Resolution	Refresh rate
1	VGA	640×480	60Hz
2	SVGA	800×600	60Hz
3	XGA	1024×768	60Hz
4	SXGA	1280×1024	60Hz
5	WXGA	1600×900	60Hz
6	WUXGA	1920×1080	60Hz
7	4K	3840×2160	30Hz
8			60Hz

Remark: Under 4K mode, 60Hz refresh rate is effective only under HDMI version 2.0/2.1.

ZHEJIANG DAHUA VISION TECHNOLOGY CO., LTD.

Address: No.1399 Binxing Road, Binjiang District, Hangzhou, P. R. China | Website: www.dahuasecurity.com |
Postcode: 310053
Email: overseas@dahuatech.com | Fax: +86-571-87688815 | Tel: +86-571-87688883